

**WATER CURVE Concealed body spray - Chrome**





IMO

36 514 979



- AQUAPRESSURE FLOW, max. flow rate 6.8 l/min (at 3 bar)
- water jet adjustable
- cover plate 120 x 60 mm
- 1/2" connection
- This product reduces water consumption by % (compared to requirements of EAct '92)
- This product can contribute to Water Use Reduction in LEED® Green Building Rating
- This product can help a building meet the requirements of Green Building Rating Systems, e.g. LEED®, BREEAM®, DGNB

Fits: IMO, LULU, MADISON, MEM, TARA, CL.1, LISSÉ, VAIA, META, CYO

	Chrome	36 514 979-00 0010
	Brushed Platinum	36 514 979-06 0010
	Platinum	36 514 979-08 0010
	Dark Chrome	36 514 979-19 0010
	Light Gold	36 514 979-26 0010
	Brushed Light Gold	36 514 979-27 0010
	Brushed Durabrass (23kt Gold)	36 514 979-28 0010
	Matte Black	36 514 979-33 0010
	Brushed Bronze	36 514 979-42 0010
	Brushed Champagne (22kt Gold)	36 514 979-46 0010
	Champagne (22kt Gold)	36 514 979-47 0010
	Brushed Chrome	36 514 979-93 0010
	Brushed Dark Platinum	36 514 979-99 0010

**Required miscellaneous**

**Concealed adapter -**

35 080 970-90  
0010



36 514 979

mm [inches]

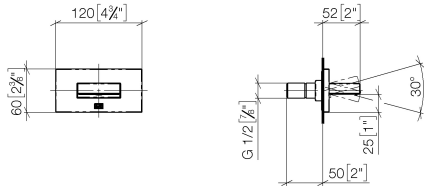

**Flow rate chart**

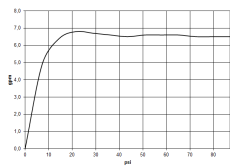

**Trajectory diagram**

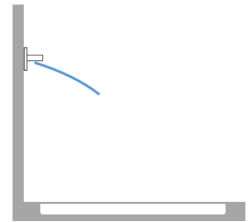
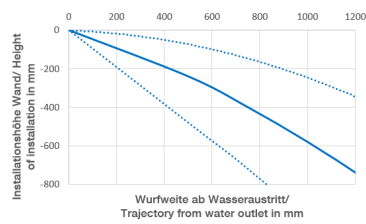

**Codes & Standards**

ASME  
A112.18.1/CSA  
B125.1

California Energy  
Commission  
(CEC)



## WATER CURVE Concealed body spray - Chrome

---

IMO

36 514 979

### Certificates

---

IAPMO\_4976 (4).

36 514 979

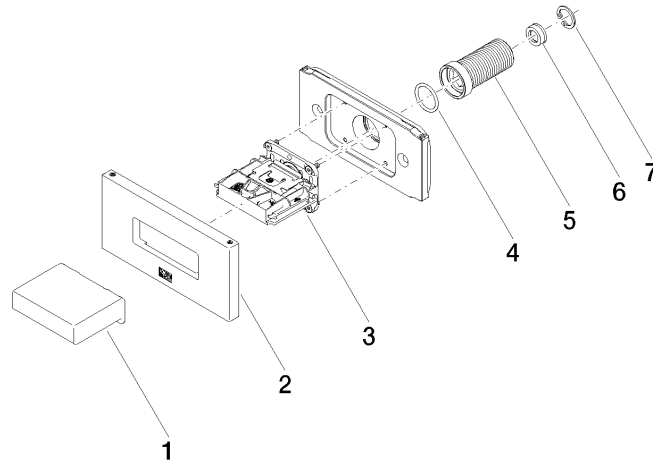

**Spare parts list**

No.	Item Number	Name	Quantity used	Delivery time
1	09 17 01 230-00	casing	1	10
2	90 27 97 041 00-00	rosette	1	10
3	90 29 03 088 00 90	insert	1	2
4	90 14 10 010 00 90	seal	1	2
5	09 24 04 336 90	nipple	1	2
6	09 23 01 165 90	flow reducer	1	2
7	09 16 01 014 90	ring	1	2